

DUAL SMALL SIGNAL SURFACE MOUNT TRANSISTOR

- We declare that the material of product compliance with RoHS requirements.
- S- Prefix for Automotive and Other Applications Requiring Unique Site and Control Change Requirements; AEC-Q101 Qualified and PPAP Capable.

ORDERING INFORMATION

Device	Marking	Shipping
LMBT4401DW1T1G S-LMBT4401DW1T1G	2X	3000/Tape&Reel
LMBT4401DW1T3G S-LMBT4401DW1T3G	2X	10000/Tape&Reel

MAXIMUM RATINGS

Rating	Symbol	Value	Unit
Collector–Emitter Voltage	V_{CE0}	40	Vdc
Collector–Base Voltage	V_{CBO}	60	Vdc
Emitter–Base Voltage	V_{EBO}	6.0	Vdc
Collector Current — Continuous	I_C	600	mAdc

THERMAL CHARACTERISTICS

Characteristic	Symbol	Max	Unit
Total Package Dissipation ⁽¹⁾ $T_A = 25^\circ\text{C}$	P_D	150	mW
Thermal Resistance Junction to Ambient	$R_{\theta JA}$	833	$^\circ\text{C}/\text{W}$
Junction and Storage Temperature Range	T_J, T_{stg}	-55 to +150	$^\circ\text{C}$

DEVICE MARKING

LMBT4401DW1T1G = 2X

ELECTRICAL CHARACTERISTICS ($T_A = 25^\circ\text{C}$ unless otherwise noted.)

Characteristic	Symbol	Min	Max	Unit
----------------	--------	-----	-----	------

OFF CHARACTERISTICS

Collector–Emitter Breakdown Voltage (2) ($I_C = 1.0 \text{ mAdc}, I_B = 0$)	$V_{(BR)CEO}$	40	—	Vdc
Collector–Base Breakdown Voltage ($I_C = 0.1 \text{ mAdc}, I_E = 0$)	$V_{(BR)CBO}$	60	—	Vdc
Emitter–Base Breakdown Voltage ($I_E = 0.1 \text{ mAdc}, I_C = 0$)	$V_{(BR)EBO}$	6.0	—	Vdc
Base Cutoff Current ($V_{CE} = 35 \text{ Vdc}, V_{EB} = 0.4 \text{ Vdc}$)	I_{BEV}	—	0.1	μAdc
Collector Cutoff Current ($V_{CE} = 35 \text{ Vdc}, V_{EB} = 0.4 \text{ Vdc}$)	I_{CEX}	—	0.1	μAdc

1. Device mounted on FR4 glass epoxy printed circuit board using the minimum recommended footprint.
2. Pulse Test: Pulse Width $\leq 300 \mu\text{s}$; Duty Cycle $\leq 2.0\%$.

LMBT4401DW1T1G S-LMBT4401DW1T1G

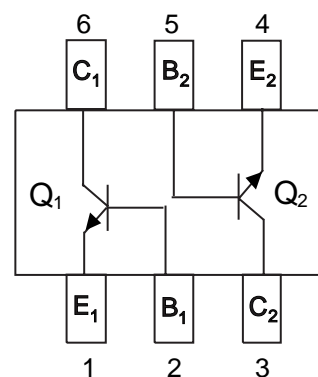
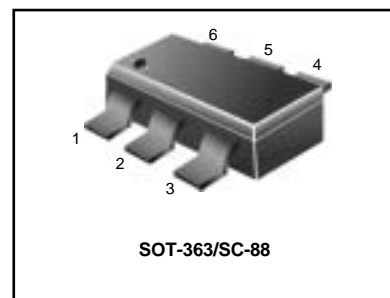

LMBT4401DW1T1G;S-LMBT4401DW1T1G

ELECTRICAL CHARACTERISTICS ($T_A = 25^\circ\text{C}$ unless otherwise noted) (Continued)

Characteristic	Symbol	Min	Max	Unit
ON CHARACTERISTICS (2)				
DC Current Gain ($I_C = 0.1\text{ mA}$, $V_{CE} = 1.0\text{ Vdc}$) ($I_C = 1.0\text{ mA}$, $V_{CE} = 1.0\text{ Vdc}$) ($I_C = 10\text{ mA}$, $V_{CE} = 1.0\text{ Vdc}$) ($I_C = 150\text{ mA}$, $V_{CE} = 1.0\text{ Vdc}$) ($I_C = 500\text{ mA}$, $V_{CE} = 2.0\text{ Vdc}$)	h_{FE}	20 40 80 100 40	— — — 300 —	—
Collector–Emitter Saturation Voltage ($I_C = 150\text{ mA}$, $I_B = 15\text{ mA}$) ($I_C = 500\text{ mA}$, $I_B = 50\text{ mA}$)	$V_{CE(sat)}$	— —	0.4 0.75	Vdc
Base–Emitter Saturation Voltage ($I_C = 150\text{ mA}$, $I_B = 15\text{ mA}$) ($I_C = 500\text{ mA}$, $I_B = 50\text{ mA}$)	$V_{BE(sat)}$	0.75 —	0.95 1.2	Vdc

SMALL–SIGNAL CHARACTERISTICS

Current–Gain — Bandwidth Product ($I_C = 20\text{ mA}$, $V_{CE} = 10\text{ Vdc}$, $f = 100\text{ MHz}$)	f_T	250	—	MHz
Collector–Base Capacitance ($V_{CB} = 5.0\text{ Vdc}$, $I_E = 0$, $f = 1.0\text{ MHz}$)	C_{cb}	—	6.5	pF
Emitter–Base Capacitance ($V_{EB} = 0.5\text{ Vdc}$, $I_C = 0$, $f = 1.0\text{ MHz}$)	C_{eb}	—	30	pF
Input Impedance ($V_{CE} = 10\text{ Vdc}$, $I_C = 1.0\text{ mA}$, $f = 1.0\text{ kHz}$)	h_{ie}	1.0	15	k Ω
Voltage Feedback Ratio ($V_{CE} = 10\text{ Vdc}$, $I_C = 1.0\text{ mA}$, $f = 1.0\text{ kHz}$)	h_{re}	0.1	8.0	$\times 10^{-4}$
Small–Signal Current Gain ($V_{CE} = 10\text{ Vdc}$, $I_C = 1.0\text{ mA}$, $f = 1.0\text{ kHz}$)	h_{fe}	40	500	—
Output Admittance ($V_{CE} = 10\text{ Vdc}$, $I_C = 1.0\text{ mA}$, $f = 1.0\text{ kHz}$)	h_{oe}	1.0	30	μmhos

SWITCHING CHARACTERISTICS

Delay Time	($V_{CC} = 30\text{ Vdc}$, $V_{EB} = 2.0\text{ Vdc}$)	t_d	—	15	ns
Rise Time	($I_C = 150\text{ mA}$, $I_{B1} = 15\text{ mA}$)	t_r	—	20	
Storage Time	($V_{CC} = 30\text{ Vdc}$, $I_C = 150\text{ mA}$)	t_s	—	225	ns
Fall Time	($I_{B1} = I_{B2} = 15\text{ mA}$)	t_f	—	30	

2. Pulse Test: Pulse Width $\leq 300\ \mu\text{s}$; Duty Cycle $\leq 2.0\%$.

SWITCHING TIME EQUIVALENT TEST CIRCUITS

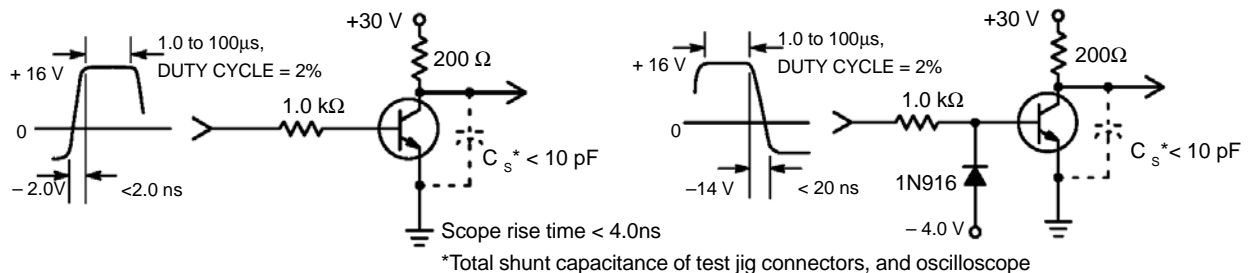

Figure 1. Turn–On Time

Figure 2. Turn–Off Time

TRANSIENT CHARACTERISTICS

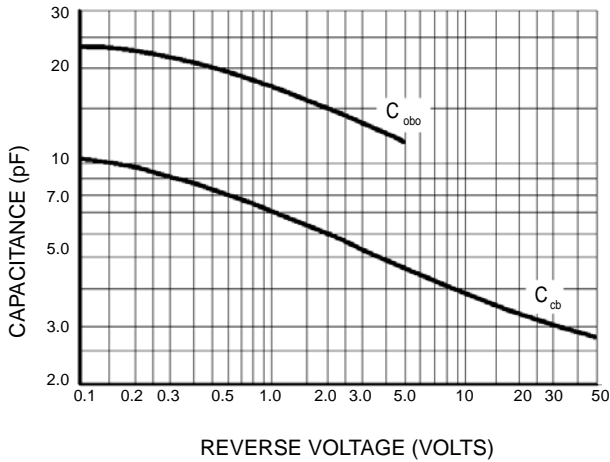

Figure 3. Capacitance

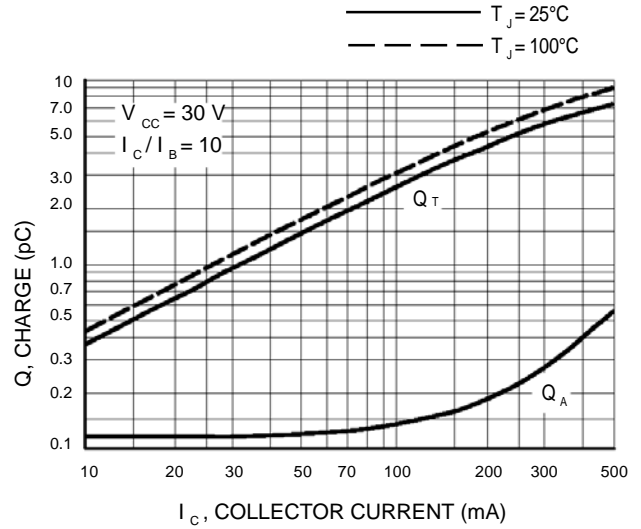

Figure 4. Charge Data

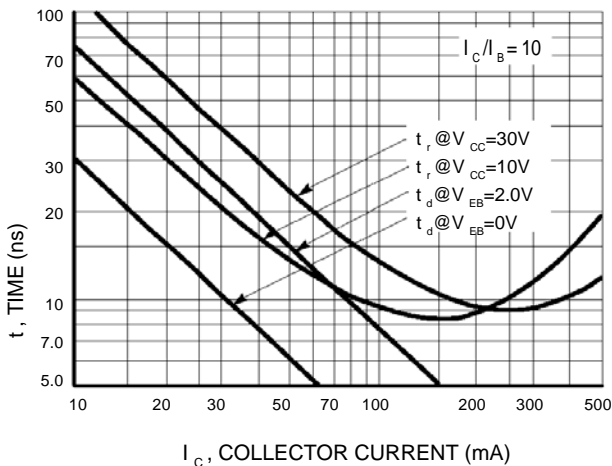

Figure 5. Turn-On Time

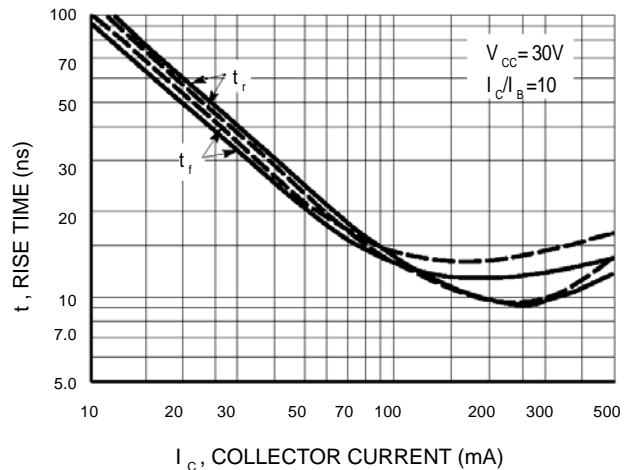

Figure 6. Rise and Fall Time

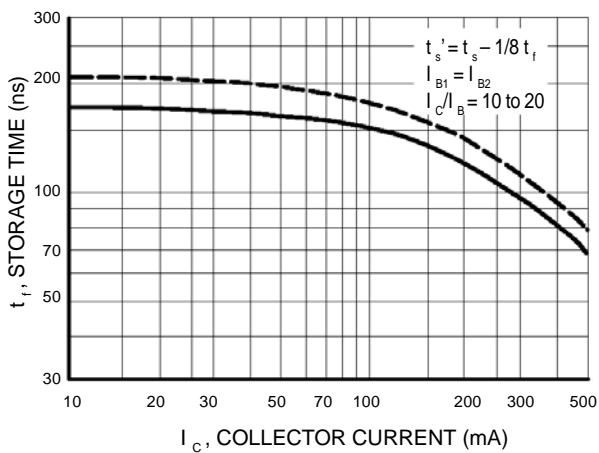

Figure 7. Storage Time

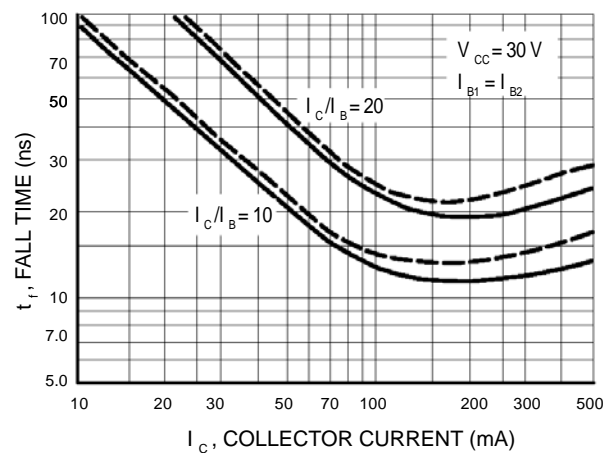

Figure 8. Fall Time

LMBT4401DW1T1G;S-LMBT4401DW1T1G

SMALL-SIGNAL CHARACTERISTICS

NOISE FIGURE

$V_{CE} = 10 \text{ Vdc}$, $T_A = 25^\circ\text{C}$
Bandwidth = 1.0 Hz

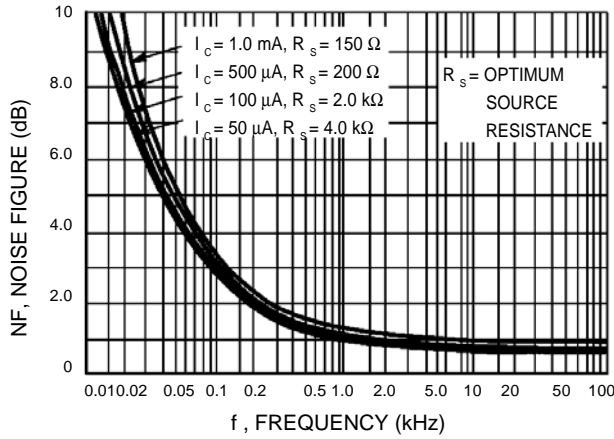

Figure 9. Frequency Effects

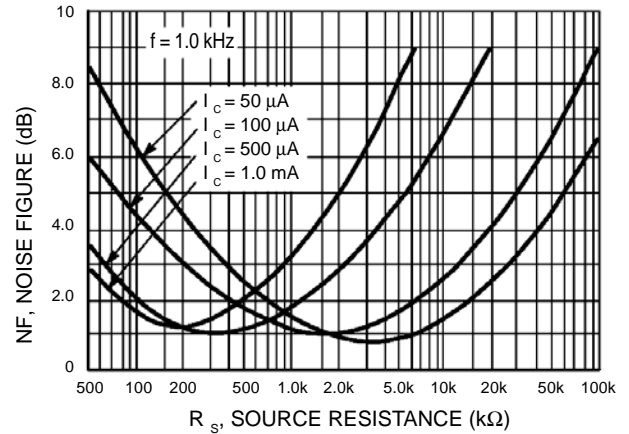

Figure 10. Source Resistance Effects

h PARAMETERS

$(V_{CE} = 10 \text{ Vdc}$, $f = 1.0 \text{ kHz}$, $T_A = 25^\circ\text{C}$)

This group of graphs illustrates the relationship between h_{fe} and other “h” parameters for this series of resistors. To obtain these curves, a high-gain and a low-gain unit were selected from the LMBT4401LT1 lines, and the same units were used to develop the correspondingly numbered curves on each graph.

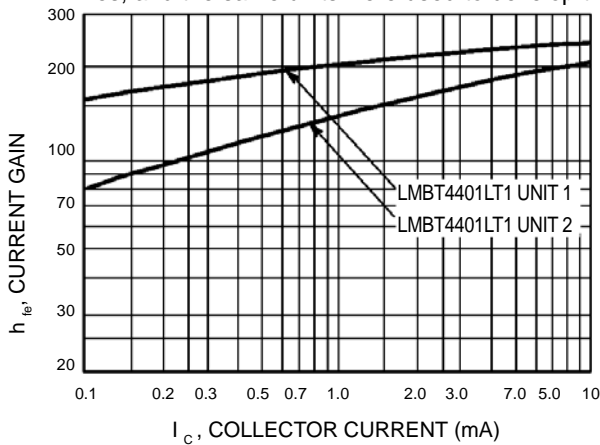

Figure 11. Current Gain

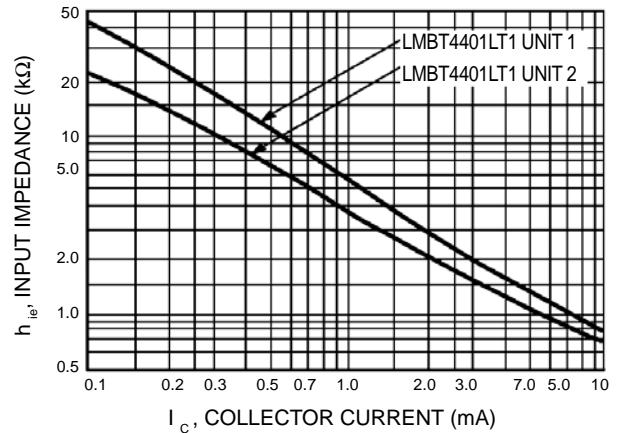

Figure 12. Input Impedance

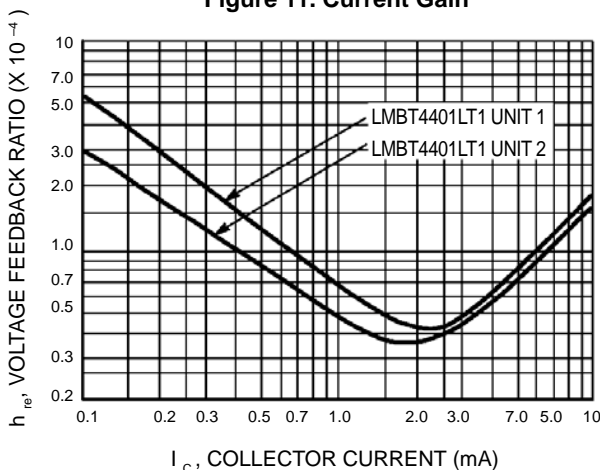

Figure 13. Voltage Feedback Ratio

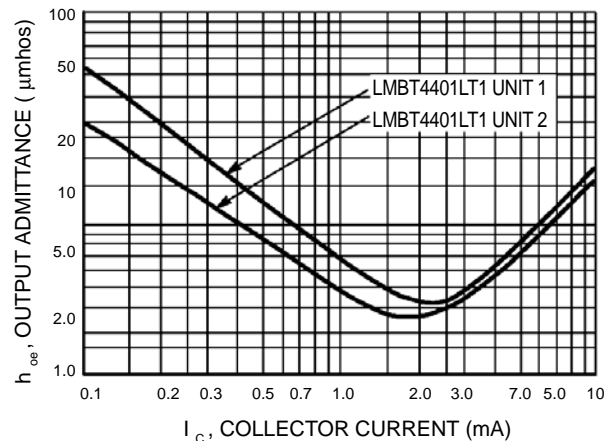

Figure 14. Output Admittance

STATIC CHARACTERISTICS

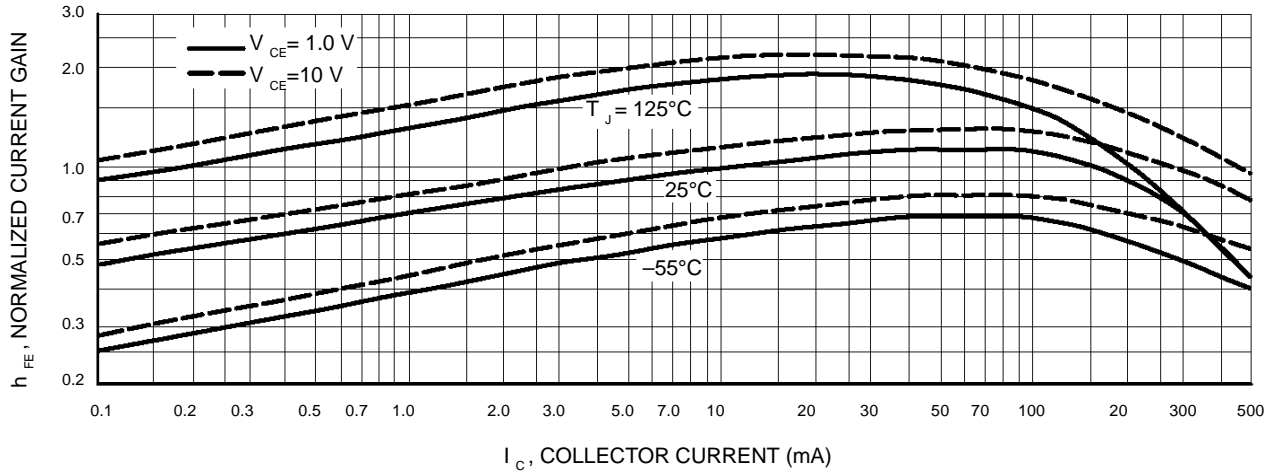

Figure 15. DC Current Gain

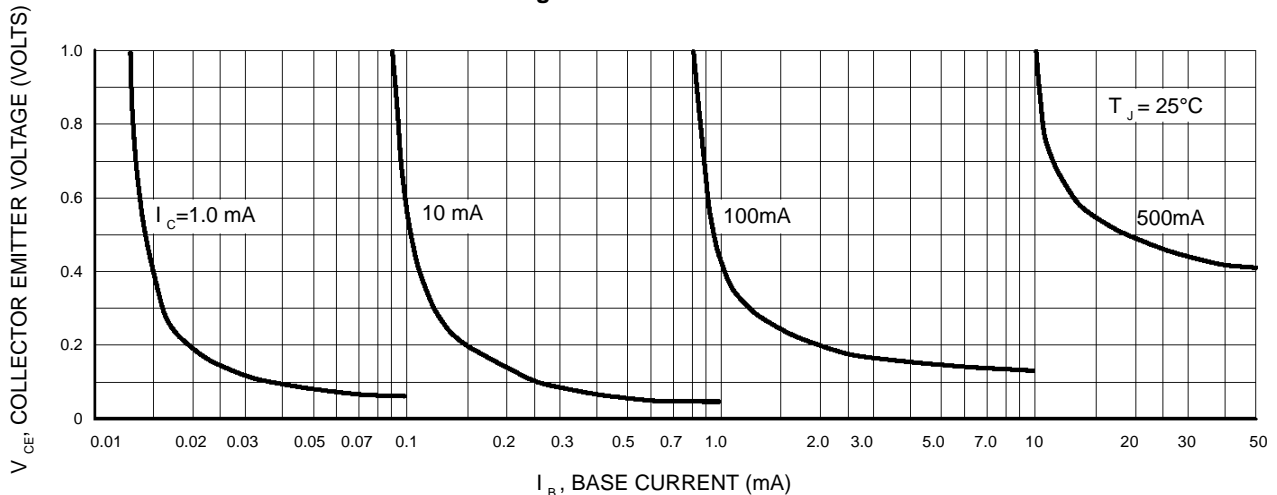

Figure 16. Collector Saturation Region

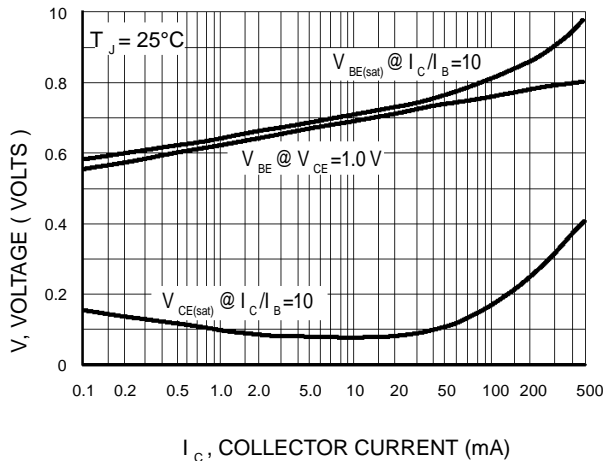

Figure 17. "On" Voltages

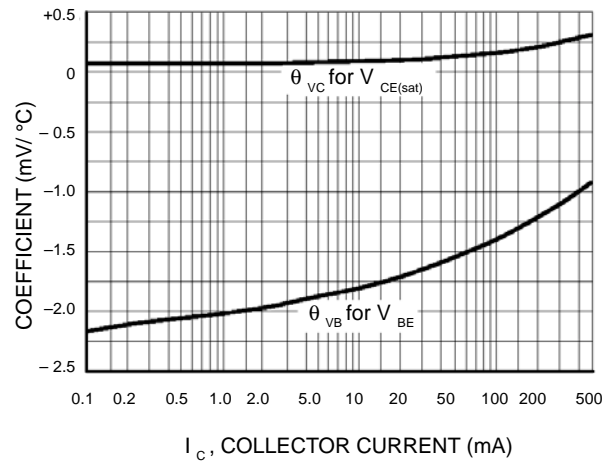
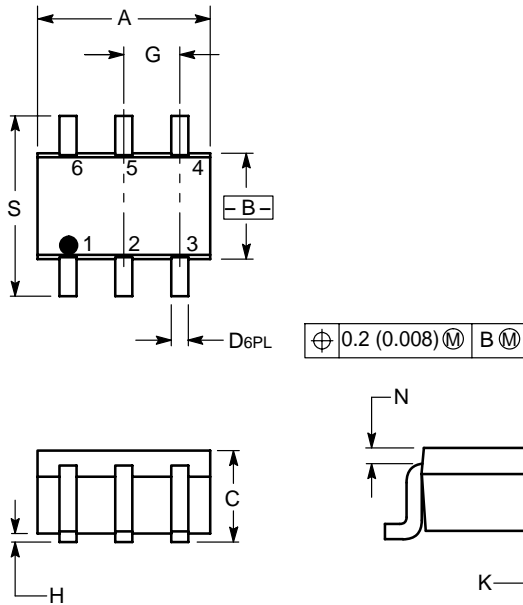

Figure 18. Temperature Coefficients

SC-88/SOT-363

NOTES:

1. DIMENSIONING AND TOLERANCING PER ANSI Y14.5M, 1982.
2. CONTROLLING DIMENSION: INCH.



DIM	INCHES		MILLIMETERS	
	MIN	MAX	MIN	MAX
A	0.071	0.087	1.80	2.20
B	0.045	0.053	1.15	1.35
C	0.031	0.043	0.80	1.10
D	0.004	0.012	0.10	0.30
G	0.026 BSC		0.65 BSC	
H	---	0.004	---	0.10
J	0.004	0.010	0.10	0.25
K	0.004	0.012	0.10	0.30
N	0.008 REF		0.20 REF	
S	0.079	0.087	2.00	2.20

- PIN 1. EMITTER 2
 2. BASE 2
 3. COLLECTOR 1
 4. EMITTER 1
 5. BASE 1
 6. COLLECTOR 2

